



PEUGEOT
508 4D

03/2011-08/2018

Cat. No. P/039

E20

E20 55R-01 5190

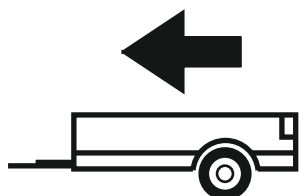

2250kg

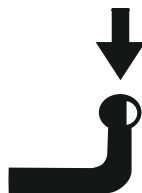

80kg

D = 10,80kN

D (kN) =



MAX kg x MAX kg

x 0,00981



MAX kg + MAX kg

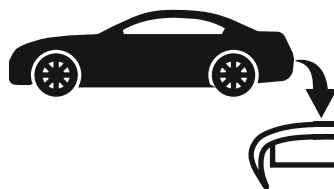

IMIOLA HAK-POL

96-111 KOWIESY, CHOJNATA 23A, POLAND

Tel. + 48 46 831 73 31, fax +48 831 74 29

e-mail: office@imiola.pl, www.imiola.pl

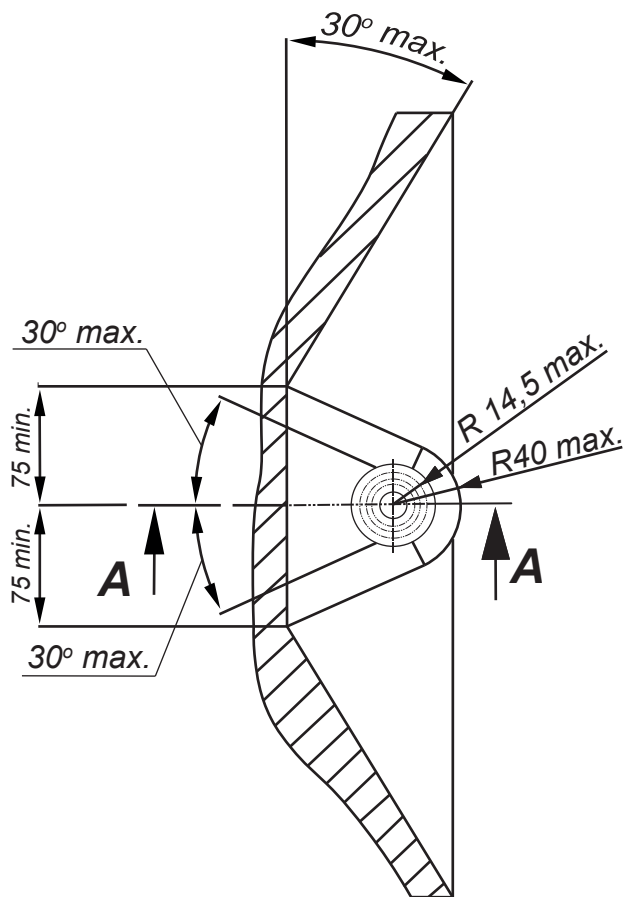

PRZEKRÓJ A-A

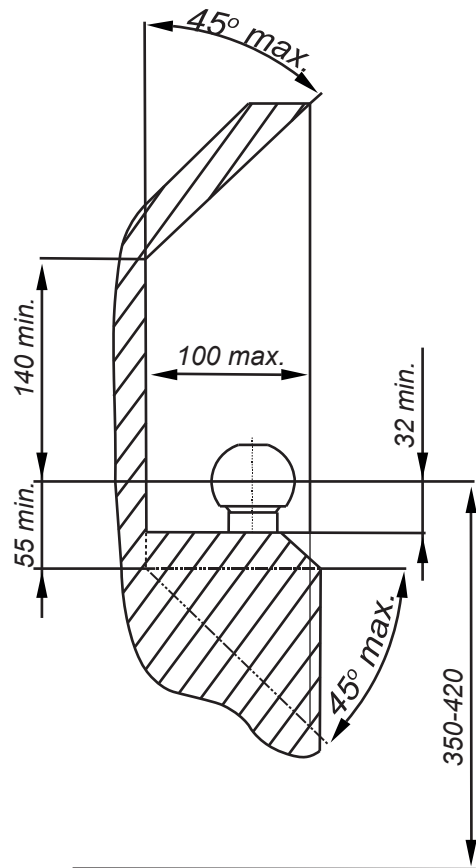

PL Należy zagwarantować przestrzeń swobodną według załącznika VII, rysunek 25a/b Regulaminu EKG ONZ 55.01 przy dopuszczalnym ciężarze całkowitym pojazdu.

F L'espace libre doit être garanti conformément à l'annexe VII, illustration de la réglementation 55.01 CE pour un poids total en charge autorisé du véhicule.







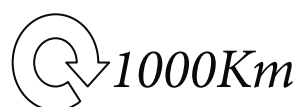

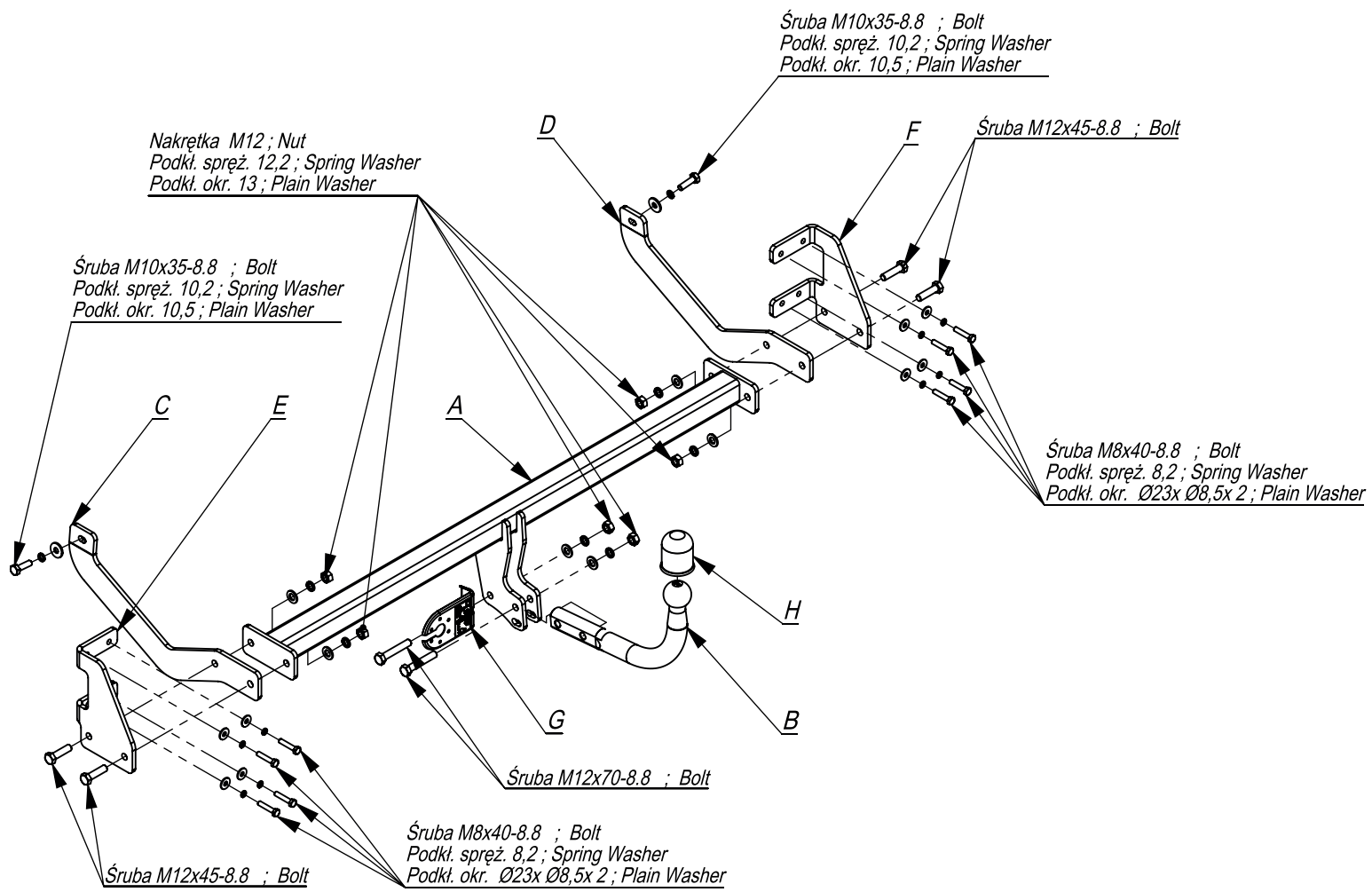

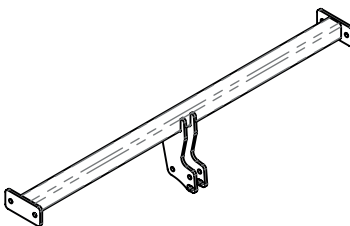
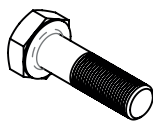
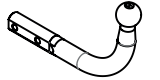
GB The clearance specified in appendix VII, diagram 25a/b of Regulation No. 55.01 UN EU must be guaranteed at laden weight of the vehicle.

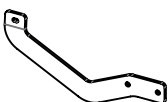
D Der Freiraum nach Anhang VII, Abbildung 25a/b der Vorschriften 55.01 EG ist zu gewährleisten bei zulässigem Gesamtgewicht des Fahrzeuges.

Moment skręcający dla śrub i nakrętek (8.8) Torgue settings for nuts and bolts (8.8)	
M8	25Nm
M10	55Nm
M12	85Nm
M14	135Nm
M16	195Nm

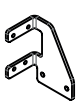



	A	x1		M12x70	2
				M12x45	4
				M10x35	2
				M8x40	8
	B	x1		M12	6
	C	x1		Ø23xØ8,5x2	8
	D	x1		13	6
	E	x1		10,5	2
	F	x1		12,2	6
	G	x1		10,2	2
	H	x1	8,2	8	

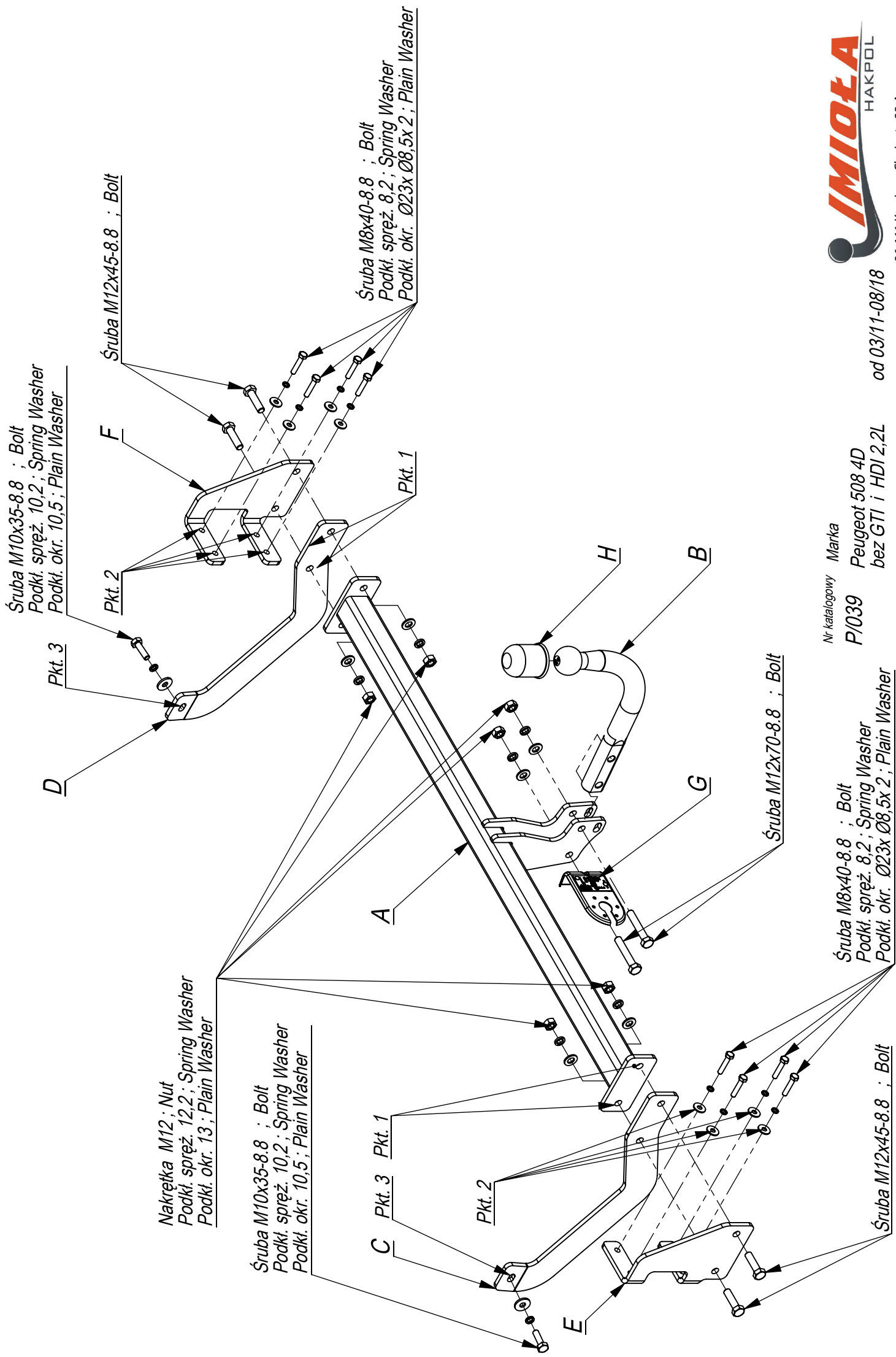

96-111 Kowiesy, Chojnata 23 A
tel. +48 46 831 73 31

Nr katalogowy Marka

P/039 Peugeot 508 4D

bez GTI i HDI 2,2L

od 03/11-08/18

- Odkręcić lampy i zderzak.
- Odkręcić wypełnienie belki zderzeniowej
- Przykręcić elementy E i F do tylnego pasa śrubami M8x40 8.8 (pkt 2).
- Przykręcić elementy C i D do podłużnic śrubami M10x35 (pkt 3).
- Przykręcić belkę haka A śrubami M12x45 8.8 (pkt 1) z elementami E i F oraz C i D.
- Wykonać wycięcie w osi, w dolnej części zderzaka na uchwyty kuli.
- Przykręcamy wypełnienie belki zderzeniowej, lampy i zderzak.
- Dokręcić wszystkie śruby z momentem według tabeli.
- Dokręcić kulę i blachę gniazda elektrycznego.
- Podłączyć instalację elektryczną.

- Disassemble the rear lamps and bumper.
- Unscrew the bumper bar filler.
- Screw the elements E and F to the rear belt with bolts M8x40 8.8 (point 2).
- Screw the elements C and D to the frame side members with bolts M10x35 8.8 (point 3).
- Screw the main bar A with bolts M12x45 8.8 (point 1) together with the elements E, F and C, D.
- Cut out the fragment in the lower part of the bumper, in its axle to put the towball handles.
- Screw the bumper bar filler, bumper and lamps.
- Tighten all the bolts according to the torque setting- see the table.
- Fix the ball and electric plate.
- Connect the electric wires.

- Dévisser le pare-chocs et les lampes.
- Dévisser le remplissage du faisceau de collision.
- Visser les éléments E et F sur la courroie arriere avec des vis M8x40 8.8 (point 2).
- Przykręcić elementy C i D do podłużnic śrubami M10x35 (pkt 3) Visser les éléments C et D aux longerons avec les boulons M10x35 (point 3).
- Fixer la barre a crochet A avec les boulons M12x45 8.8 (point 1) avec les éléments E et F et C et D.
- Faire une encoche dans l'axe, au bas du pare-chocs sur les supports de balle.
- Visser les poutres collision de remplissage, les lumi?res et les pare-chocs.
- Serrer tous les boulons avec un couple de serrage selon tableau.
- Visser la boule et la tôle de la prise électrique.
- Brancher l'installation électrique.

- Die Rückleuchten und den Stoßfänger abschrauben.
- Schrauben Sie die Kollisionsbalkenfüllung ab.
- Die Stoßstange Balken befestigenden Schrauben und das Tragteil E und F mit den Schrauben M8x40 (Punkt 2) abschrauben.
- Die AHK-Bauteile C und D mit Schrauben M10x35 (Punkt 3) an den Längsträgern festschrauben.
- Befestigen Sie die Hakenstange A mit Schrauben M12x45 8.8 (Punkt 1) mit den Elementen E und F und C und D.
- In der Achse des Stoßfängers einen Ausschnitt für die Kugelhalterung ausführen.
- Wir schrauben die Füllung des Aufprallträgers, die Lampe und den Stoßfänger an.
- Ziehen Sie alle Schrauben mit dem Drehmoment gemäß der Tabelle an.
- Die Kugel und den Steckdose-Blech anziehen.
- Die elektrische Installation anschließen.

- Desenrosque las lámparas y el parachoques.
- Desenrosque el relleno del haz de colisión.
- Atornille los elementos E y F a la correa trasera con pernos M8x40 8.8 (punto 2).
- Apretar los elementos C y D a la largueros con tornillos M10x35 (punto 3).
- Fije la barra de gancho A con tornillos M12x45 8.8 (punto 1) con los elementos E, F, C y D.
- Haga una muesca en el eje, en la parte inferior del parachoques en el soporte de bolas.
- Atornillamos el relleno de la viga de impacto, la lámpara y el parachoques.
- Apretar todos los tornillos con el par según la tabla anterior..
- Apretar la bola y la placa de la toma eléctrica.
- Conectar la instalación eléctrica.

