



2011 -

## CHEVROLET ORLANDO

Cat. No. CH/011

E20

E20 55R-01 5350

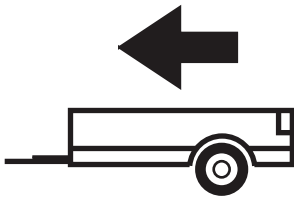

1600Kg



75Kg

**D** = 9,90kN

**D (kN) =**



MAX kg

x

MAX kg

x 0,00981



MAX kg

+

MAX kg



IMIOLA HAK-POL

96-111 KOWIESY, CHOJNATA 23A, POLAND

Tel. + 48 46 831 73 31, fax +48 831 74 29

e-mail: [office@imiola.pl](mailto:office@imiola.pl), [www.imiola.pl](http://www.imiola.pl)

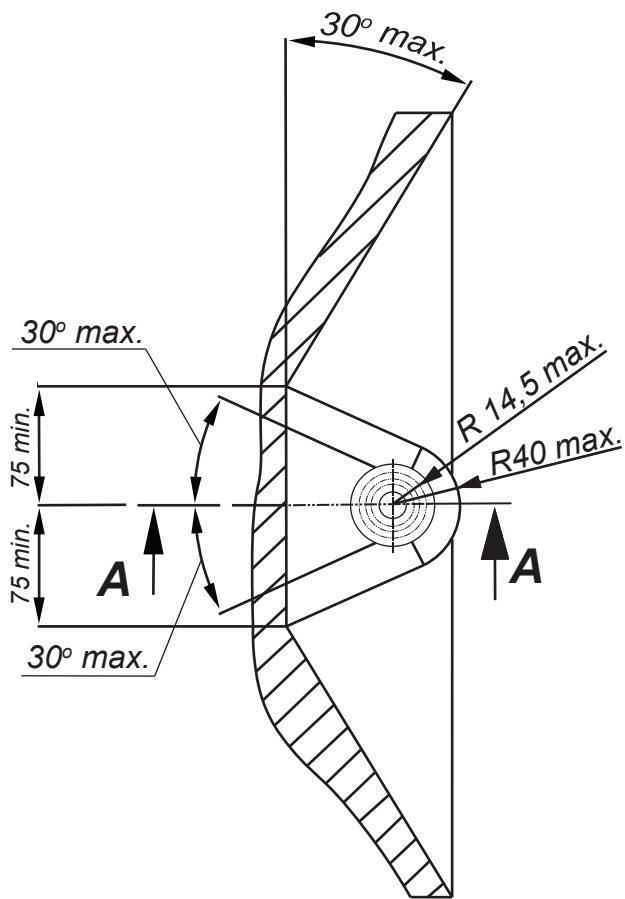

## PRZEKRÓJ A-A

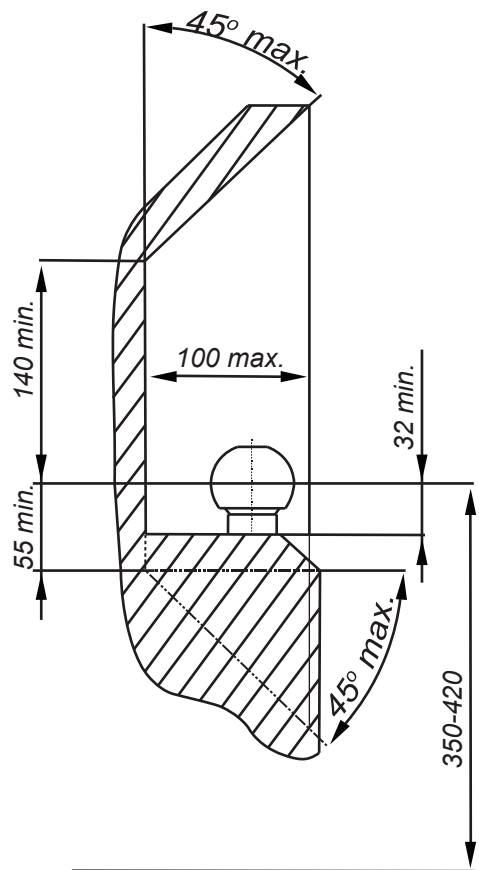

**PL** Należy zagwarantować przestrzeń swobodną według załącznika VII, rysunek 25a/b Regulaminu EKG ONZ 55.01 przy dopuszczalnym ciężarze całkowitym pojazdu.

**F** L'espace libre doit être garanti conformément à l'annexe VII, illustration de la réglementation 55.01 CE pour un poids total en charge autorisé du véhicule.

**GB** The clearance specified in appendix VII, diagram 25a/b of Regulation No. 55.01 UN EU must be guaranteed at laden weight of the vehicle.

**D** Der Freiraum nach Anhang VII, Abbildung 25a/b der Vorschriften 55.01 EG ist zu gew 25a/bahrleiten bei zulässigem Gesamtgewicht des Fahrzeuges.

Moment skrczący dla śrub i nakrętek (8.8) Torque settings for nuts and bolts (8.8)	
M8	25Nm
M10	55Nm
M12	85Nm
M14	135Nm
M16	195Nm

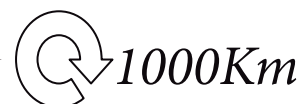

Śruba M10x35-8.8 ; Bolt  
 Podkł. spręż. 10,2 ; Spring Washer  
 Podkł. okr. Ø30x Ø10,5x 3 ; Plain Washer







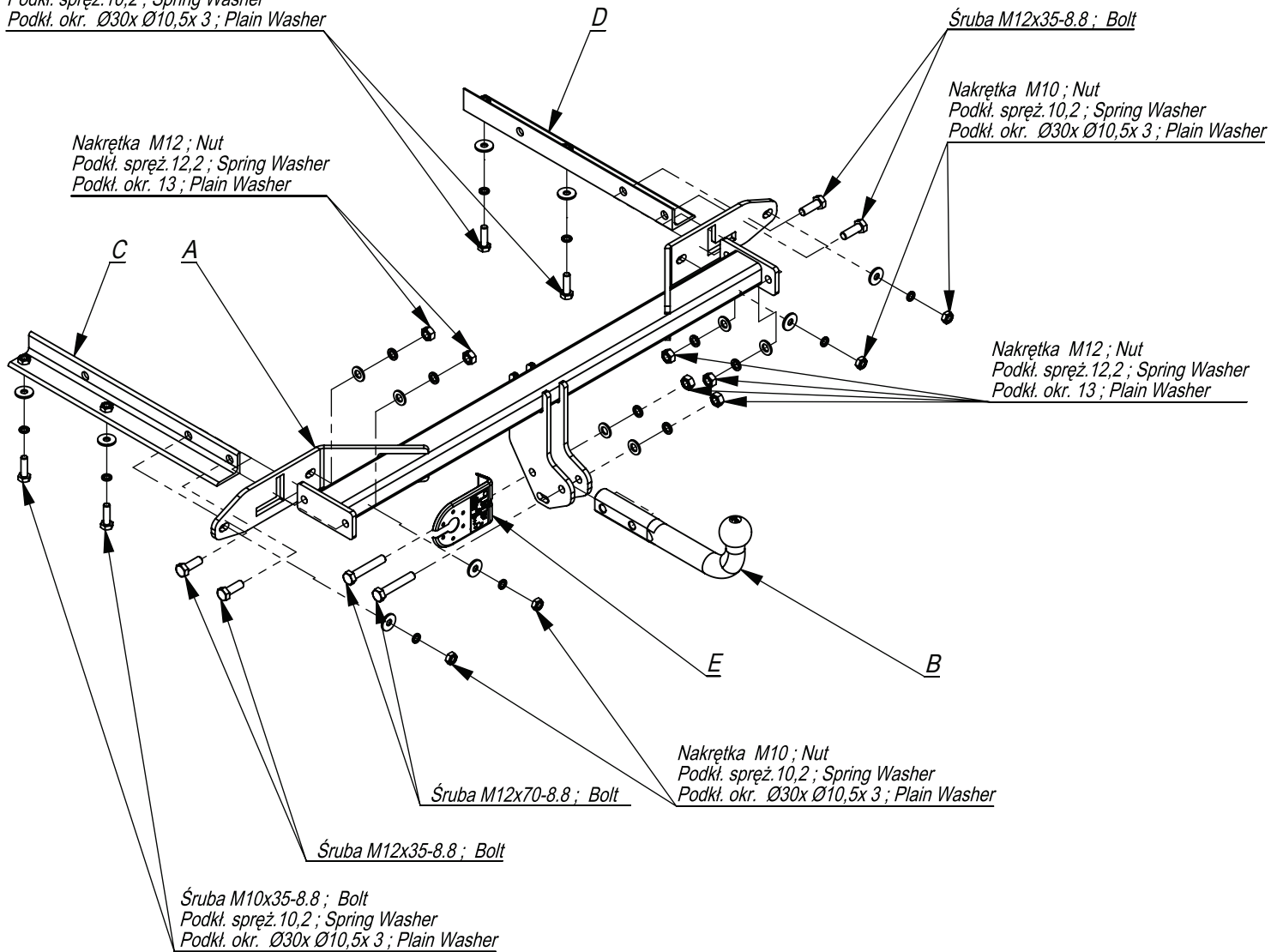

Śruba M12x35-8.8 ; Bolt

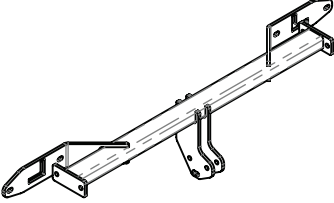
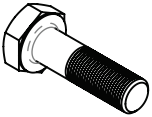
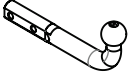
Nakrętka M10 ; Nut  
 Podkł. spręż. 10,2 ; Spring Washer  
 Podkł. okr. Ø30x Ø10,5x 3 ; Plain Washer

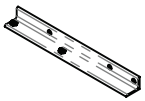
Nakrętka M12 ; Nut  
 Podkł. spręż. 12,2 ; Spring Washer  
 Podkł. okr. 13 ; Plain Washer

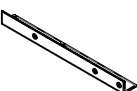
Nakrętka M12 ; Nut  
 Podkł. spręż. 12,2 ; Spring Washer  
 Podkł. okr. 13 ; Plain Washer



	A	x1		M12x70	2
				M12x35	4
				M10x35	4
	B	x1		M12	6
				M10	4
	C	x1		Ø30xØ10,5x3	8
	D	x1		13	6
	E	x1		12,2	6
				10,2	8

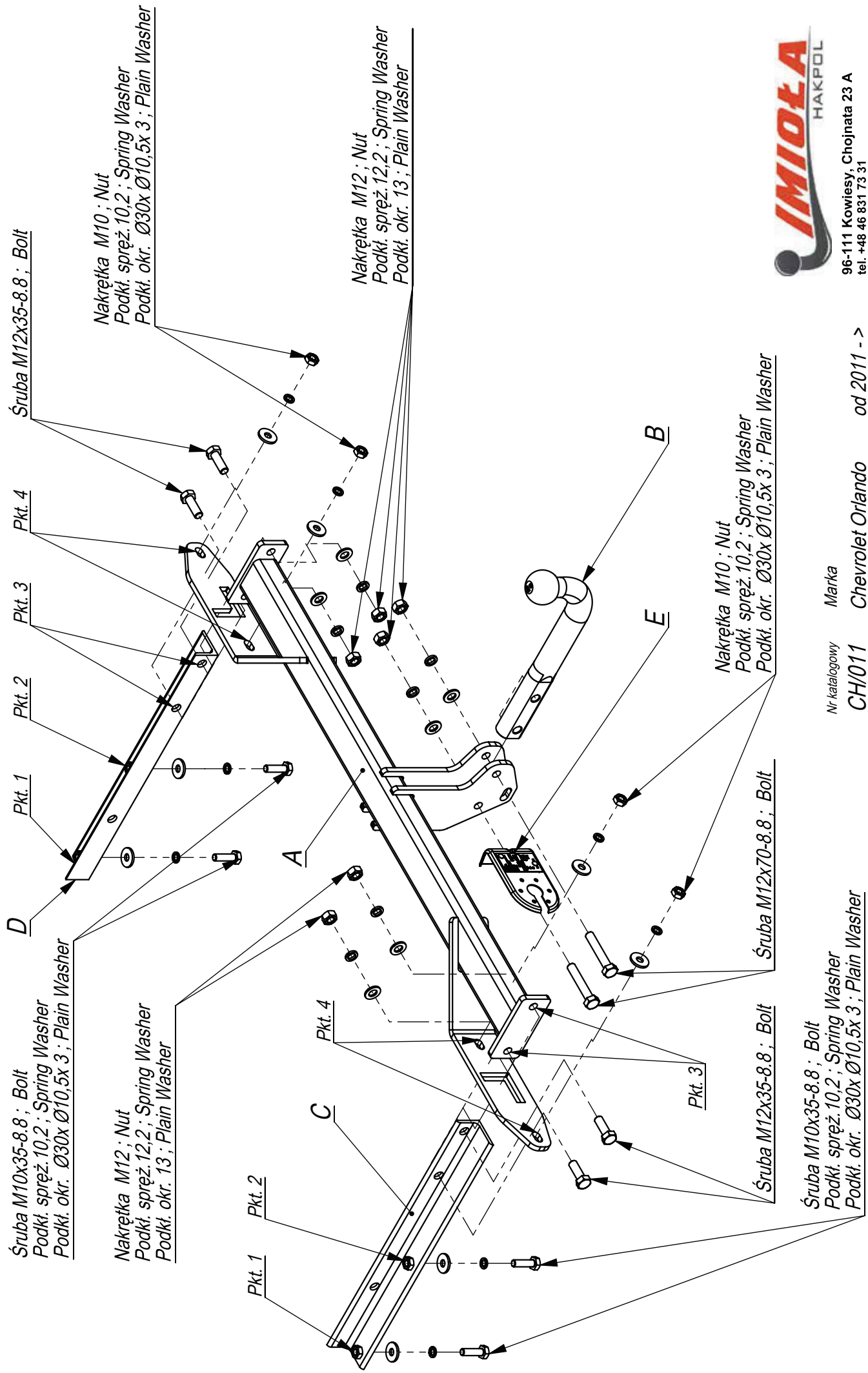

96-111 Kowiesy, Chojnata 23 A  
tel. +48 46 831 73 31

Nr katalogowy  
**CH/011**  
 Marka  
**Chevrolet Orlando**  
 od 2011 ->

