



Cat. No. **Y/024**

MITSHUBISHI OUTLANDER

04/07-09/12

CITROEN C-CROSSER

09/07-08/12

PEUGEOT 4007

09/07-08/12

e20

e20*94/20*0875*00

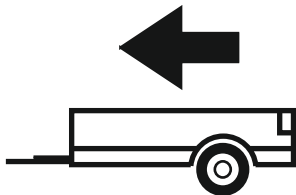

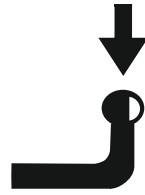

2000kg



100kg

D=11,00kN

$$D \text{ (kN)} = \frac{\text{MAX kg} \times \text{MAX kg}}{\text{MAX kg} + \text{MAX kg}} \times 0,00981$$

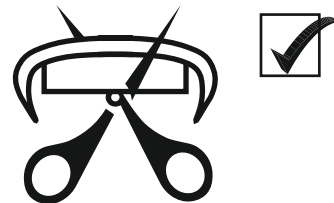
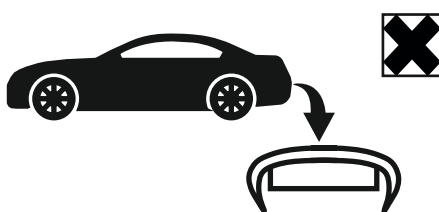



IMIOLA HAK-POL

96-111 KOWIESY, CHOJNATA 23A, POLAND

Tel. + 48 46 831 73 31, fax +48 831 74 29

e-mail: office@imiola.pl, www.imiola.pl



PRZEKRÓJ A-A

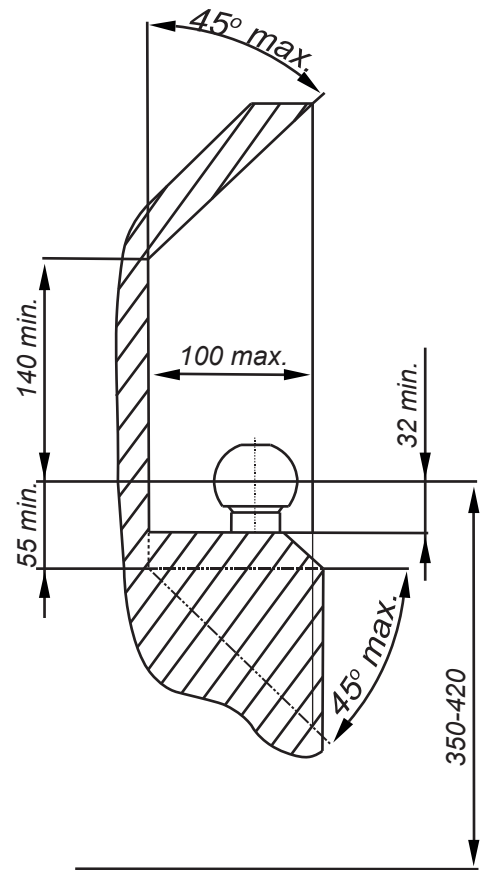

PL Należy zagwarantować przestrzeń swobodną według załącznika VII, rysunek 25a/b Regulaminu EKG ONZ 55.01 przy dopuszczalnym ciężarze całkowitym pojazdu.

F L'espace libre doit être garanti conformément à l'annexe VII, illustration de la réglementation 55.01 CE pour un poids total en charge autorisé du véhicule.







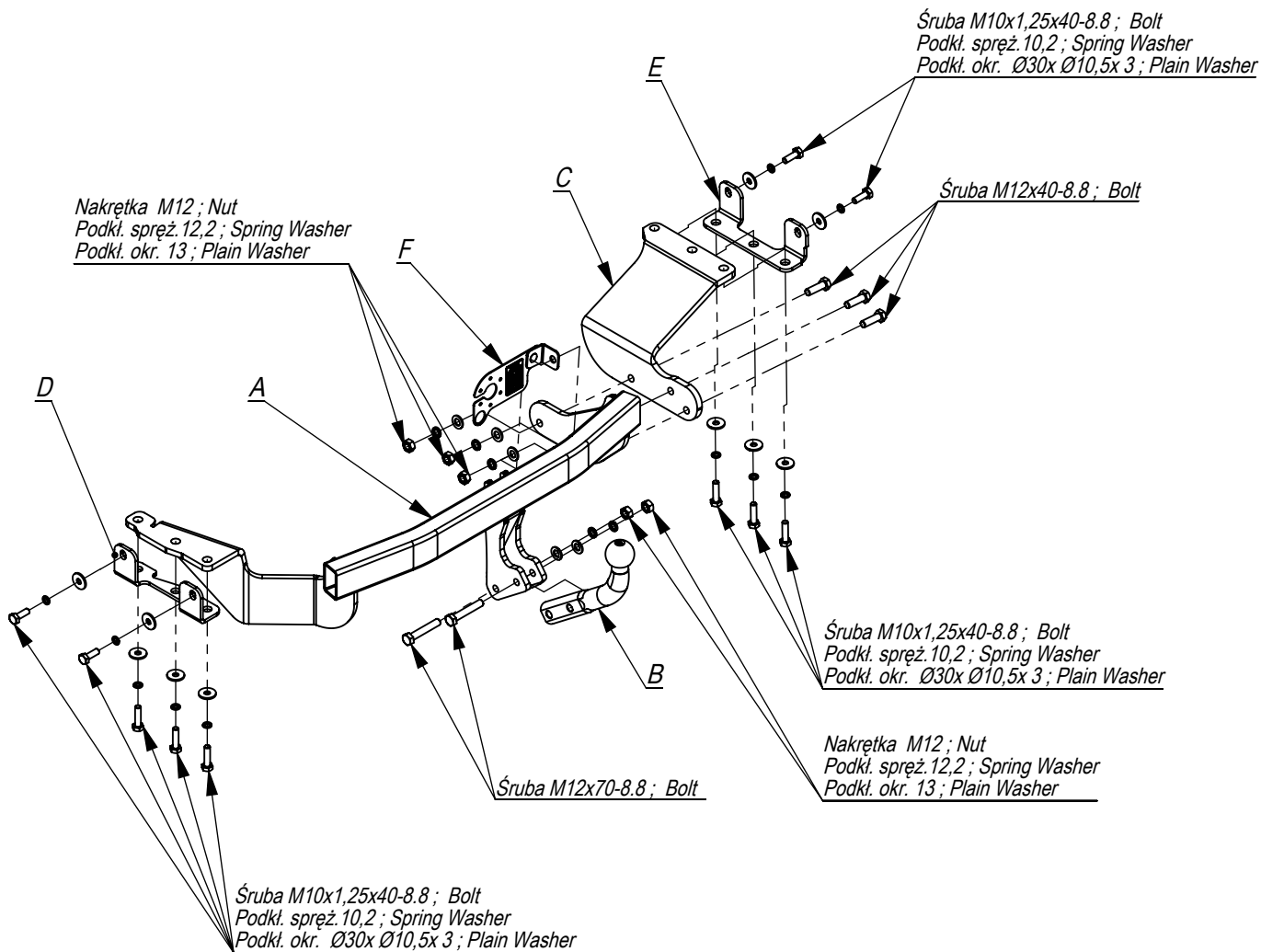

GB The clearance specified in appendix VII, diagram 25a/b of Regulation No. 55.01 UN EU must be guaranteed at laden weight of the vehicle.

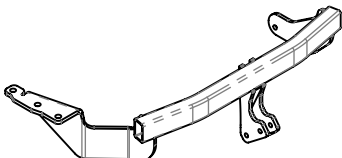
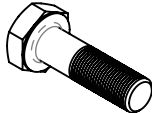
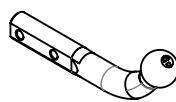
D Der Freiraum nach Anhang VII, Abbildung 25a/b der Vorschriften 55.01 EG ist zu gew 25a/bahrleisten bei zulässigem Gesamtgewicht des Fahrzeuges.

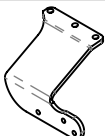
Moment skręcący dla śrub i nakrętek (8.8) Torque settings for nuts and bolts (8.8)	
M8	25Nm
M10	55Nm
M12	85Nm
M14	135Nm
M16	195Nm





	A	x1		M12x70	2
				M12x40	3
				M10x1,25x40	10
	B	x1		M12	5
					Ø30xØ10,5x3
	C	x1		13	5
					12,2
	E	x1		10,2	10
					F

Śruba M10x1,25x40-8.8 ; Bolt
Podkl. spręż. 10,2 ; Spring Washer
Podkl. okr. Ø30x Ø10,5x 3 ; Plain Washer

Śruba M12x40-8.8 ; Bolt

Pkt. 1 E Pkt. 3

Nakrętka M12 ; Nut
Podkl. spręż. 12,2 ; Spring Washer
Podkl. okr. 13 ; Plain Washer

C Pkt. 2 F

Pkt. 4 D A

D A

Śruba M10x1,25x40-8.8 ; Bolt
Podkl. spręż. 10,2 ; Spring Washer
Podkl. okr. Ø30x Ø10,5x 3 ; Plain Washer

Nakrętka M12 ; Nut
Podkl. spręż. 12,2 ; Spring Washer
Podkl. okr. 13 ; Plain Washer

Śruba M12x70-8.8 ; Bolt

Śruba M10x1,25x40-8.8 ; Bolt
Podkl. spręż. 10,2 ; Spring Washer
Podkl. okr. Ø30x Ø10,5x 3 ; Plain Washer



96-111 Kowiesy, Chojnata 23 A
tel. +48 46 831 73 31

Nr katalogowy
Y/024

Marka
Mitsubishi Outlander
peugeot 4007; Citroen C-Crosser

od 2007 ->

od 2007 ->

