



DODGE
RAM1500 DS

2019 -

Cat. No. AM/108

E20

E20*55R01/07*005753*00

V = 12,00kN



D = 22,50kN

D (kN) =



MAX kg x MAX kg x 0,00981



MAX kg + MAX kg

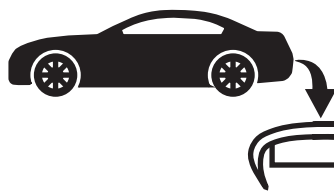

IMIOLA HAK-POL

96-111 KOWIESY, CHOJNATA 23A, POLAND

Tel. + 48 46 831 73 31, fax +48 831 74 29

e-mail: office@imiola.pl, www.imiola.pl

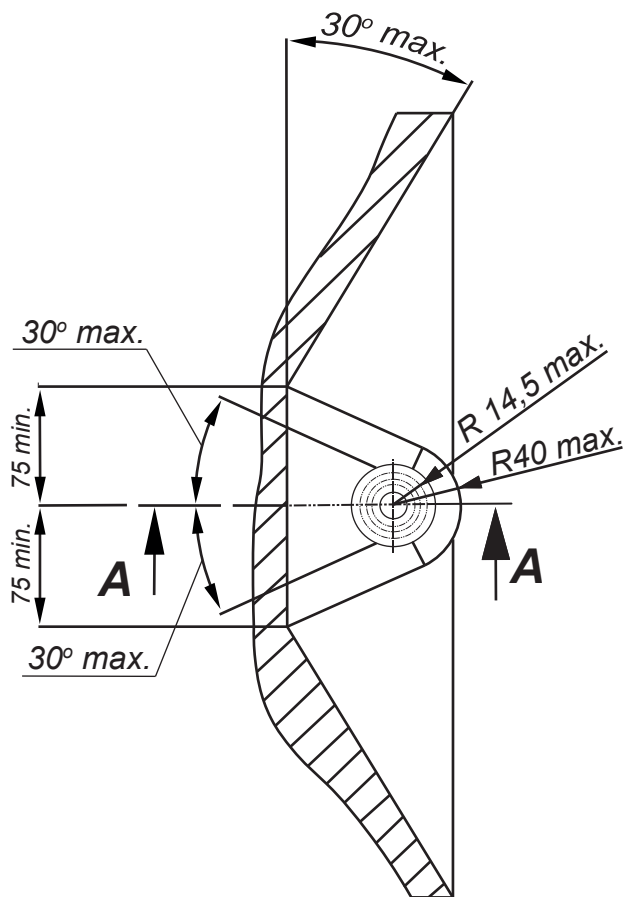

PRZEKRÓJ A-A

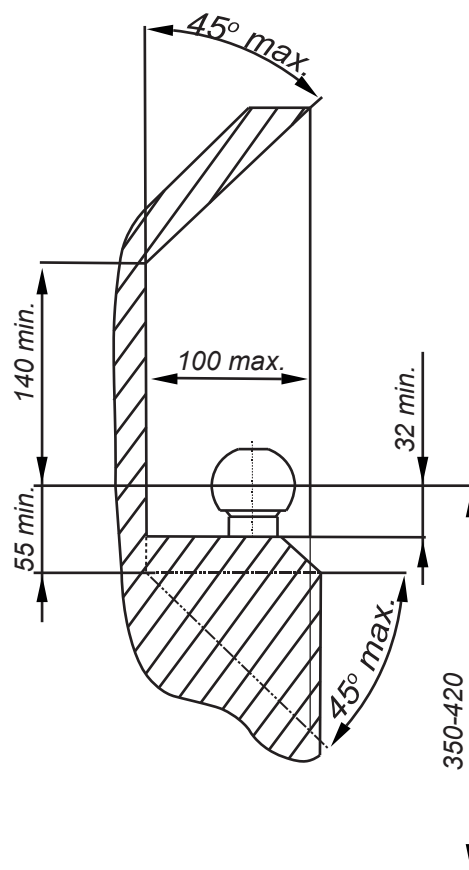

PL Należy zagwarantować przestrzeń swobodną według załącznika VII, rysunek 25a/b Regulaminu EKG ONZ 55.01 przy dopuszczalnym ciężarze całkowitym pojazdu.

F L'espace libre doit être garanti conformément à l'annexe VII, illustration de la réglementation 55.01 CE pour un poids total en charge autorisé du véhicule.







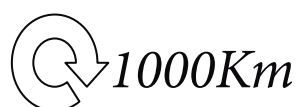

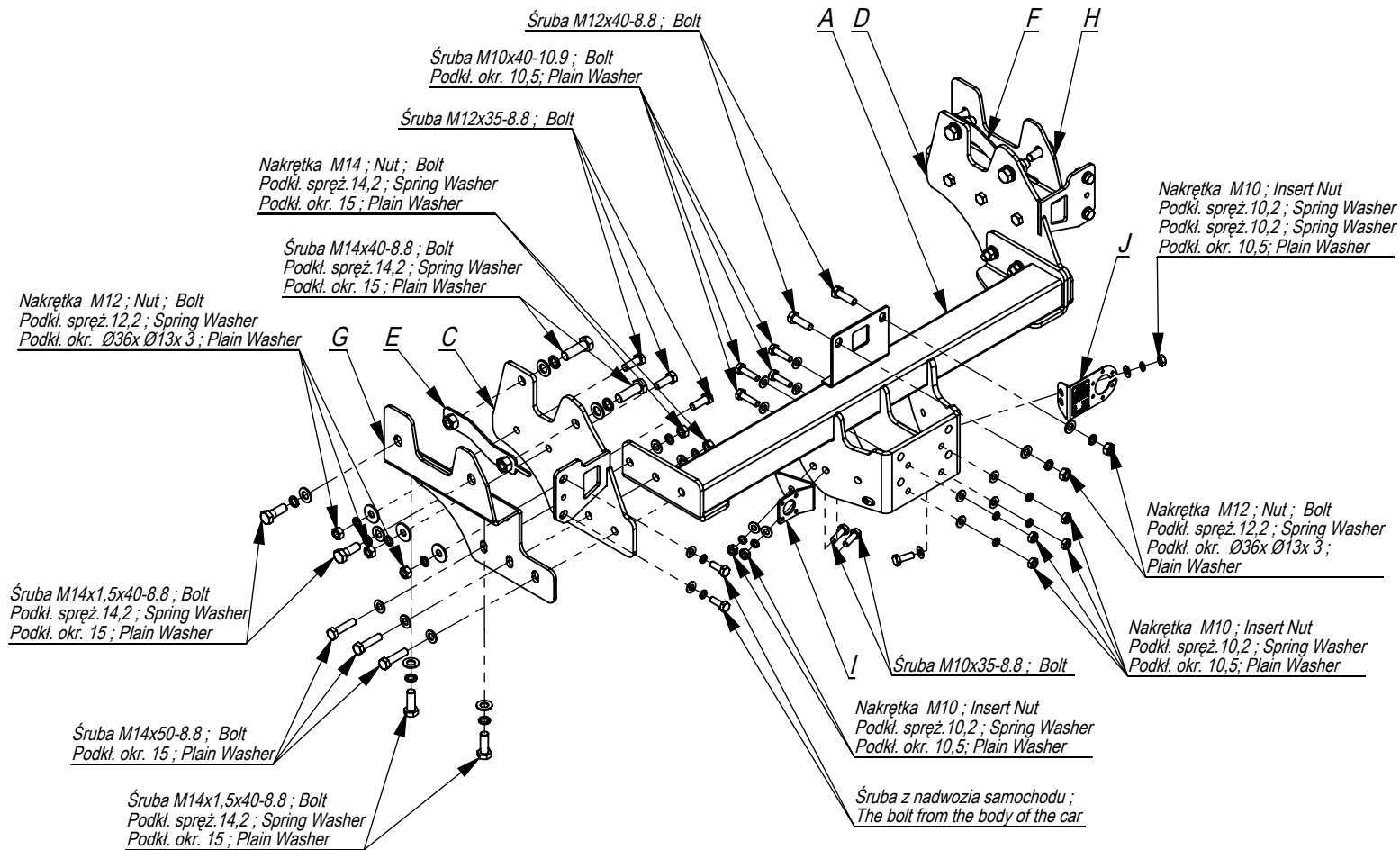

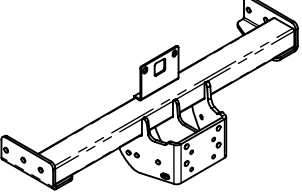
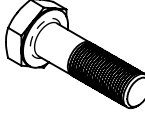

GB The clearance specified in appendix VII, diagram 25a/b of Regulation No. 55.01 UN EU must be guaranteed at laden weight of the vehicle.

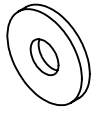
D Der Freiraum nach Anhang VII, Abbildung 25a/b der Vorschriften 55.01 EG ist zu gewährleisten bei zulässigem Gesamtgewicht des Fahrzeuges.

Moment skręcający dla śrub i nakrętek (8.8) Torque settings for nuts and bolts (8.8)	
M8	25Nm
M10	55Nm
M12	85Nm
M14	135Nm
M16	195Nm





	A	x1		M14x1,5x40	8
				M14x40	4
				M14x50	6
				M12x40	2
				M12x35	6
				M10x40 10:9	4
				M10x35	3
	C	x1		M14	4
				M12	8
				M10	7
	D	x1		Ø36xØ13x3	8
				15	22
				13	2
	E	x1		10,5	11
				14,2	18
				12,2	8
	F	x1		10,2	7
	G	x2			
	H	x1			
	I	x1			
	J	x1			

Śruba M12x40-8.8 ; Bolt

Śruba M10x40-10.9 ; Bolt

Podkt. okr. 10,5 ; Plain Washer

Śruba M12x35-8.8 ; Bolt

Śruba M14x40-8.8 ; Bolt

Podkt. spręż. 14,2 ; Spring Washer

Podkt. okr. 15 ; Plain Washer

G Pkt. 4 E C Pkt. 3 Pkt. 2

Nakrętka M12 ; Nut ; Bolt

Podkt. spręż. 12,2 ; Spring Washer

Podkt. okr. Ø36x Ø13x 3 ; Plain Washer

Śruba M14x1,5x40-8.8 ; Bolt

Podkt. spręż. 14,2 ; Spring Washer

Podkt. okr. 15 ; Plain Washer

Śruba M14x50-8.8 ; Bolt

Podkt. okr. 15 ; Plain Washer

Śruba M14x1,5x40-8.8 ; Bolt

Podkt. spręż. 14,2 ; Spring Washer

Podkt. okr. 15 ; Plain Washer

Nakrętka M14 ; Nut ; Bolt

Podkt. spręż. 14,2 ; Spring Washer

Podkt. okr. 15 ; Plain Washer

A D F H

Nakrętka M10 ; Insert Nut
Podkt. spręż. 10,2 ; Spring Washer
Podkt. okr. 10,5 ; Plain Washer
Podkt. okr. 10,5 ; Plain Washer
Śruba M10x35-8.8 ; Bolt

Nakrętka M12 ; Nut

Podkt. spręż. 12,2 ; Spring Washer

Podkt. okr. Ø36x Ø13x 3 ; Plain Washer

Nakrętka M10 ; Insert Nut

Podkt. spręż. 10,2 ; Spring Washer

Podkt. okr. 10,5 ; Plain Washer

Śruba M10x35-8.8 ; Bolt

Nakrętka M10 ; Nut

Podkt. spręż. 10,2 ; Spring Washer

Podkt. okr. 10,5 ; Plain Washer

Śruba z nadwozia samochodu ;
The bolt from the body of the car

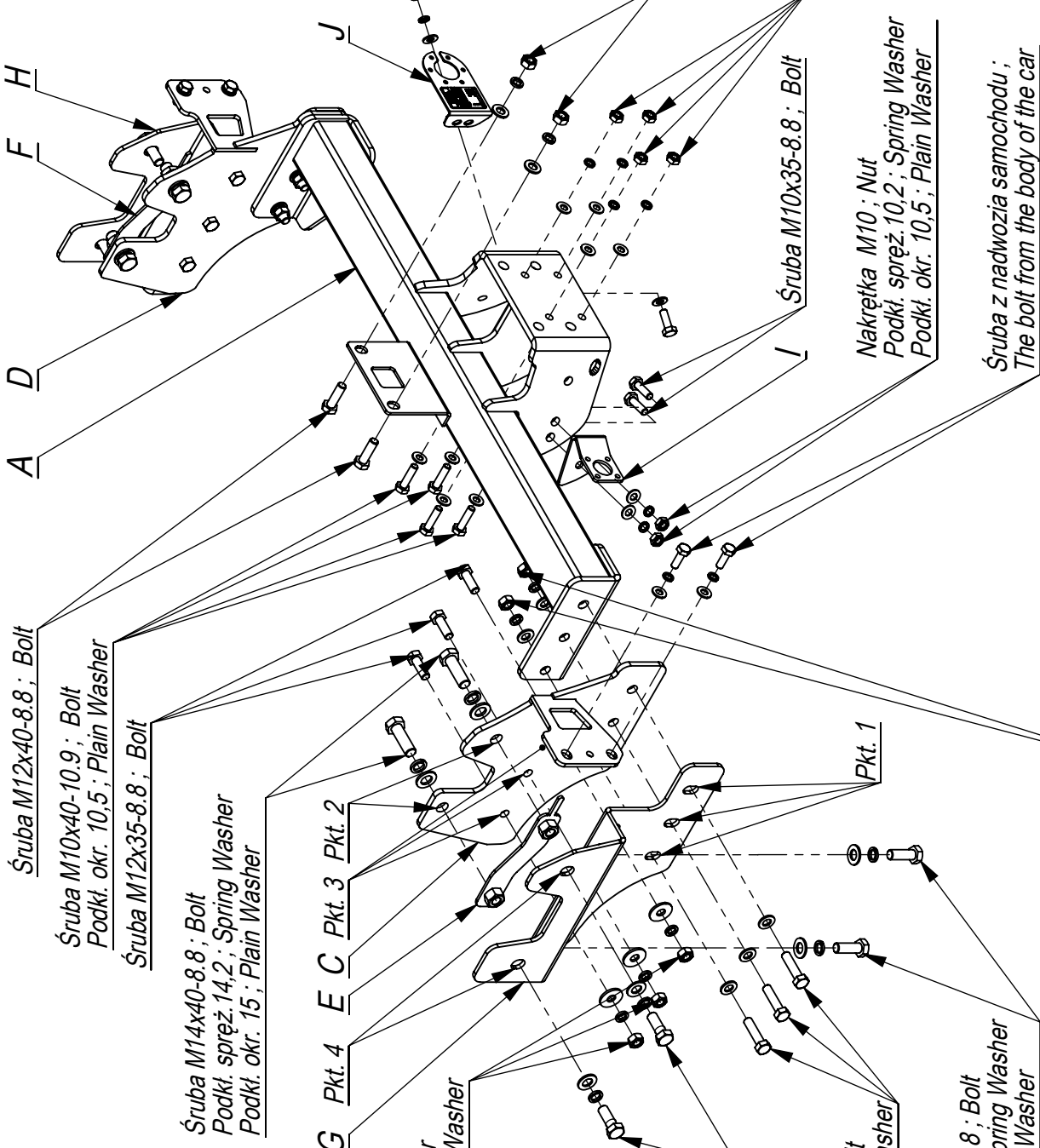

Nr katalogowy

Marka

AM/108

Dodge RAM 1500 DS od 2019 ->



96-111 Kowiesy, Chojnata 23 A
tel. +48 46 831 73 31

